

ARIS – Experts in motion

**High performance
in actuation**



ARIS Stellantriebe – Electric & pneumatic actuators,
gas components, valves and complete solutions

Welcome to the ARIS product range

Foreword

“Solutions geared to the future” - this motto perfectly reflects our corporate philosophy. As experts in electric and pneumatic actuators, gas components, valves and complete solutions, it is our mission to deliver concepts engineered for today’s demands and tomorrow’s opportunities. We have more than 50 years of experience in development, production and realisation. We keep our sights on the future, analyse the current market situation and ensure compliance with all regulatory requirements.

As a highly reliable partner, we are constantly evolving, and manufacturing top-quality products that are optimised for your system right down to the smallest component. We always strive to work as resource- and energy-efficiently as possible and gear our production towards sustainable manufacturing. In this spirit, we are delighted to present our innovative, market-oriented product range to you here.

Yours sincerely,

Rolf Schneider
Managing Director

From standard to customised – our standard product ranges and tailor-made special solutions.

s 04 | **ARIS Stellantriebe GmbH Company**

Company, applications, design – Made in Germany, Production, Quality management, product overview



s 18 | **Electric actuators**

Actuators, modulating actuators, explosion-proof actuators, HVAC actuators, PICO, linear units, customised solutions



s 30 | **Pneumatic actuators**

Single- and double-acting pneumatic actuators and quarter-turn actuators from KINETROL®



s 32 | **Industrial valves**

Industrial valves of all types and sizes for all applications



s 38 | **Gas control systems / components**

Components for gas conditioning and control



ARIS – Expertise in motion



ARIS stands for innovation, quality and precision

ARIS Stellantriebe GmbH produces robust electric actuators for industrial use at its German site in Troisdorf.

Since 2025, ARIS has been a wholly owned subsidiary of UK-based Kinetrol Ltd, which specialises in pneumatic actuator technology and has a global network of sales partnerships.

Through our international ARIS and Kinetrol team, we offer you a worldwide service and can act as a global partner for high quality electric and pneumatic products.

In 2014, we introduced the Nano, Nano+ and Tensor series – brand-new, state-of-the-art solutions built on our over 50 years of experience. Our actuators are used in demanding and safety-relevant systems in which the reliability of all components is essential. With four series to choose from, our customers will always find the right actuator.

Our product portfolio ranges from classically designed actuators to the fully electronically controlled “Tensor2” high-precision actuator.

We can advise you on which actuator type is best suited for your application and will be there to help you in every phase of your project.



KINETROL® – Technologically advanced actuator solutions and control systems for even the most demanding applications

Kinetrol was founded in 1958 as a company specialising in control technology. With its expertise in the damping sector, Kinetrol steadily expanded its know-how in the years that followed. Recognising early on the growing demand for quarter-turn actuators, the company developed and patented the pneumatic vane rotary actuator.

In order to meet the growing market demand for increasingly precise appliances for process control, Kinetrol continued to expand its range of innovative actuators and control units.

Today, Kinetrol is successful throughout the world and has four production sites in Farnham, England. The Company exports at least 80 % of its sales to countries all over the globe via its own subsidiaries and a network of distribution partners.

Kinetrol has its own inspection and testing facilities and operates a quality control programme that

includes 100% functional testing of all products and full traceability of serial numbers. The quality system is certified in accordance with ISO 9001 (2015).



ARIS & KINETROL® –
in motion worldwide

ARIS Stellantriebe GmbH

Headquarters: Germany

ARIS agencies

- > China
- > France
- > Great Britain
- > India
- > Italy
- > Japan
- > Malaysia
- > Netherlands
- > Austria
- > Poland
- > Spain
- > South Africa
- > South Korea
- > Thailand
- > Czech Republic
- > Turkey
- > USA
- > UAE

Kinetrol Ltd.

Headquarters: United Kingdom

Kinetrol agencies

- > Australia
- > Belgium
- > Brazil
- > Canada
- > Czech Republic
- > Denmark
- > Finland
- > Israel
- > Italy
- > Japan
- > Mexico
- > New Zealand
- > Norway
- > Poland
- > South Africa
- > South Korea
- > Sweden
- > Turkey

Kinetrol subsidiaries

- > China
- > France
- > Germany
- > India
- > Malaysia
- > Netherlands
- > Spain
- > Great Britain
- > USA
- > UAE

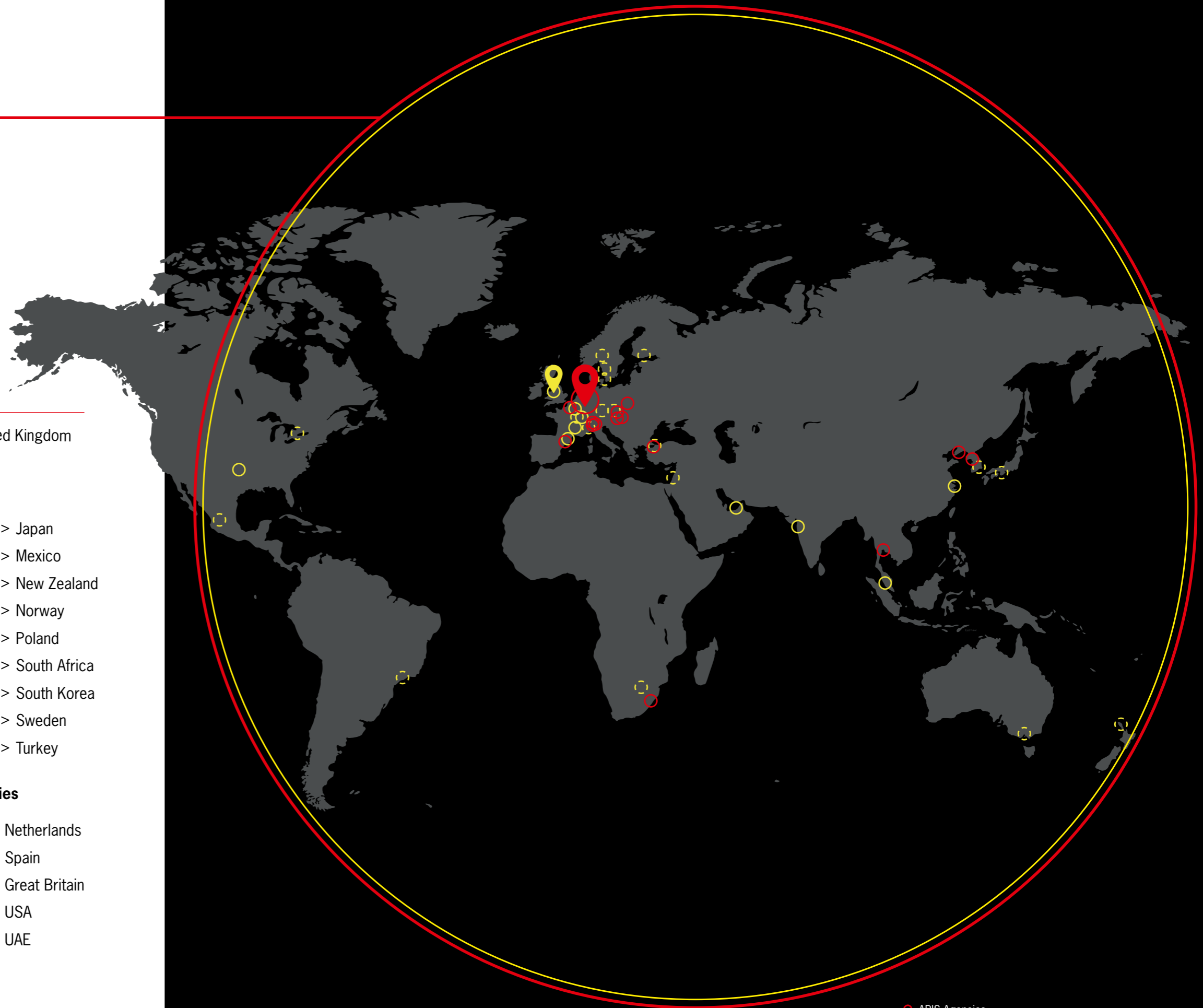

○ ARIS Agencies
○ Kinetrol Agencies
□ Kinetrol Subsidiaries

We are at home even in places you wouldn't expect

Our actuators, industrial valves, gas control systems and components have proven themselves in numerous industrial sectors over the past decades and provide industry-specific solutions for your applications and plants.

We guarantee maximum safety, precision and the highest quality standards in any environment.

Boiler systems



Industrial furnaces



Coating lines



Roasting technology



Dosing technology



Industrial combustion



Extinguishing systems



Biogas plants



Environmental technology



Industrial ventilation



Smoking technology



Silo bulk solids technology



Solar technology



Refineries



Sewage treatment plants



Pharmaceutical industry



Industrial valves



Food technology



Malting technology



Gas control systems



Chemical plants



Vehicle construction



Shipbuilding



Oil & gas industry



Grain processing



Wood processing



www.stellantriebe.de/en



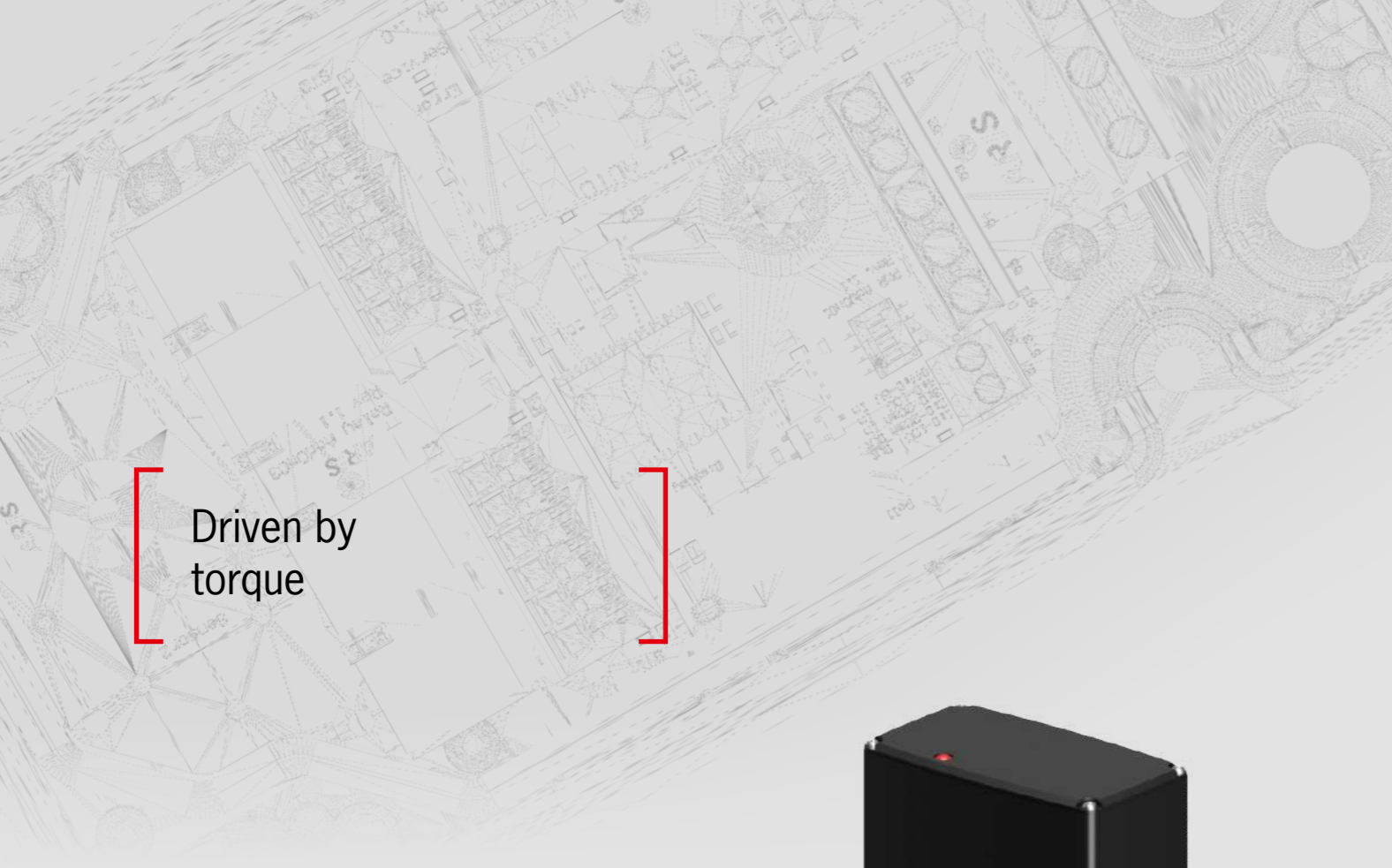

Driven by torque



Design, development and manufacturing all under one roof

50 years of experience and expertise in-house. Thanks to newly created capacity, our design department has been back at the ARIS headquarters in Troisdorf, Germany, since 2014.

This is where we develop high-quality electric actuators equipped with state-of-the-art technology. ARIS actuators are created in close collaboration between our design engineers, our technicians, our sales team, and our customers.

This enables us to develop market-orientated products from scratch and bring them to series production all under one roof.



ARIS engineering – high-quality industrial products Made in Germany

Actuators and modulating actuators, electric or pneumatic
IECEX/ATEX products Zone 1, 2 and 22

Gas control systems & components
All components required for gas conditioning and control complete with the required certifications (European standard, and in some cases DVGW).

Complete assemblies
You can order the actuator and valves together. Individually combined for your own specific application. Delivered fully assembled.

Customised solutions
Project-related or as series components. Numerous variants and options. Planned, designed and built by ARIS.

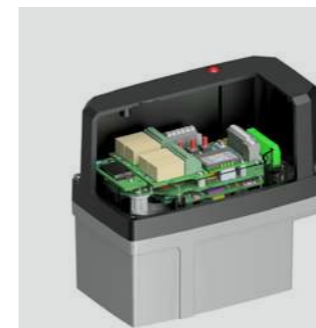

- > Electric rotary and part-turn actuators
- > Electric linear actuators as damper actuators
- > Electric linear actuators as linear cylinders
- > Ventaris, the high-precision lifting unit for valve actuation
- > PICO HVAC - the bridge between building and industrial technology
- > Pneumatic actuators, valves, gas control systems

ARIS Production – High-precision right from the start

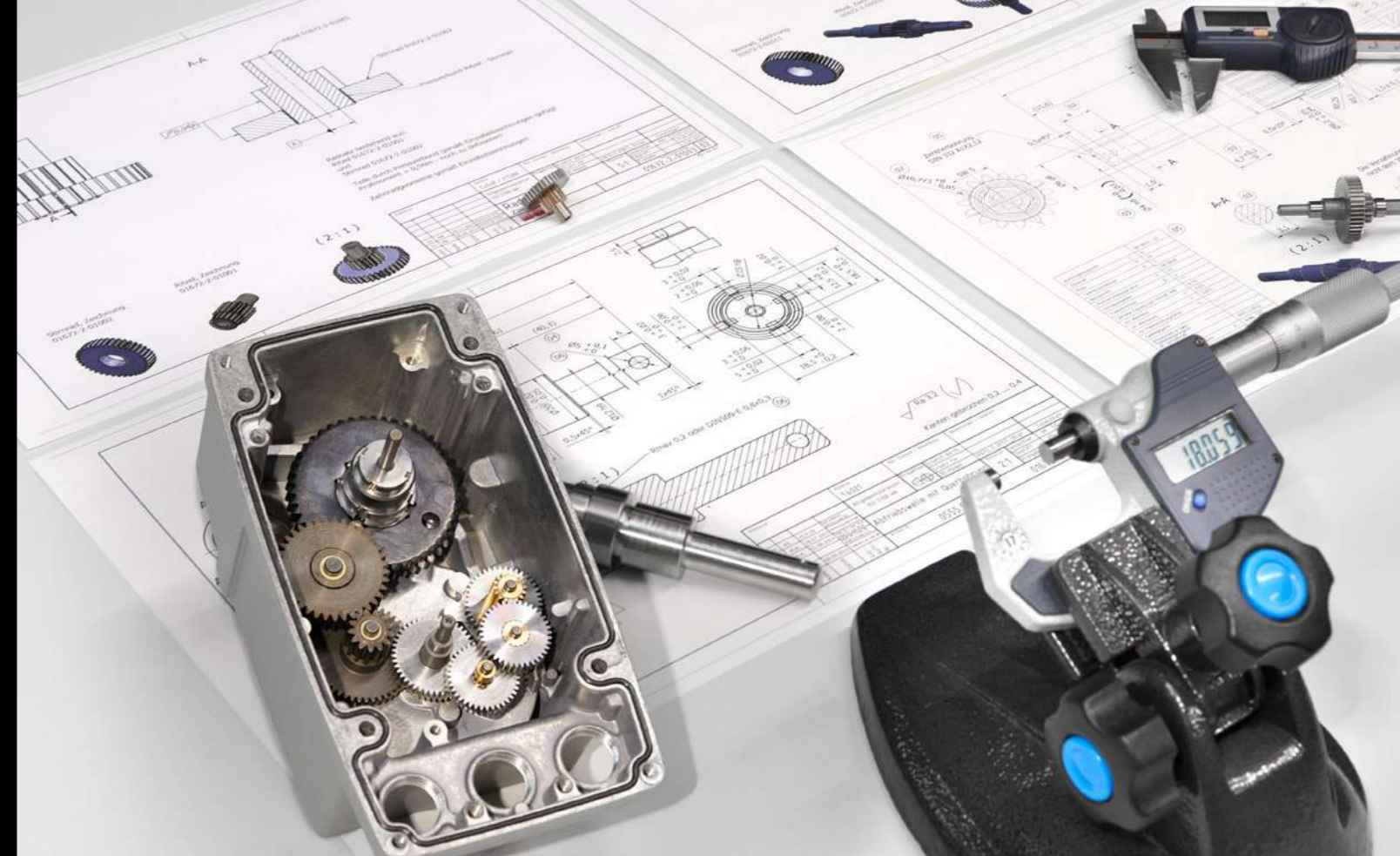

Produced under state-of-the-art conditions

We manufacture our products independently at our headquarters in Troisdorf. The electric rotary actuators Nano and Tensor, the linear actuator Linearis, and the Ex actuators are produced in our own production halls.

The actuators are assembled by qualified employees on our modern production lines and tested both mechanically and electrically. Our order centre coordinates the manufacturing and assembly work.

This is where everything comes together, ensuring the seamless tracking and planning of every order.

Thanks to our test laboratory and production facilities, we can guarantee our customers maximum flexibility, customisation, and controlled quality.



High-quality production – maximum flexibility

From standard actuators to special products, our expertise lies in the production of high-performance actuators.

Thanks to the state-of-the-art equipment in our own production facilities in Troisdorf, we are able to guarantee maximum innovation, flexibility and delivery reliability.

Our expertise gained through over 50 years of market presence and experience in the construction of actuators forms the basis for our solutions.





Consistent manufacturing quality – certified quality management

Our end-to-end quality assurance system guarantees a smooth process, from the delivery and inspection of the individual parts to the packaging and shipping of the final products.

We only dispatch goods whose functionality has been thoroughly tested.



ISO 9001:2015

ARIS quality management – tested quality right from the start



IECEX | ATEX - certified safety for your plant

We offer various solutions for use in potentially explosive environments.

The use of oversized solutions is common, often involving costly and complex Zone 1 actuators being deployed in Zone 2, even though the actual demands are much lower.

ARIS is one of the few suppliers to offer solutions for Zone 2 and 22.

The actuators for these zones have a much simpler design, but still meet all the requirements. They are certified by a notified body and can be offered at a significantly lower price. By using these variants you are able to increase the competitiveness of your plants.

We do, of course, also offer a pressure-tight encapsulated solution for use in Zone 1 areas.

You can find our current certificates in the download area of our website (scan QR code).



- > **Tensor² rotary actuator**
- > **Nano+ rotary actuator**
- > **Linearis N+ damper actuator**
- > **Linearis TE damper actuator**
- > **Ventaris valve unit**
- > **ExTensor electric actuators for potentially explosive environments**

From standard actuators to tailor-made solutions.
We offer an extensive range of excellent products.

Electric actuators

Actuators, modulating actuators, explosion-proof actuators, PICO HVAC actuators, Linearis linear units, Ventaris, complete solutions, special solutions, customised project solutions



Pneumatic actuators

Single-acting and double-acting pneumatic actuators, Part-turn actuators from KINETROL®



Industrial valves

Industrial valves of all types and sizes for all applications

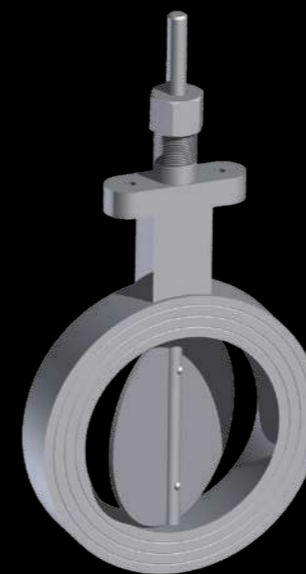

Gas control systems / components

Components for gas conditioning and control



ARIS – Experts in motion

Electric rotary and part-turn actuators



Actuators

High-quality, compact electric actuators for industrial applications



Modulating actuators

High-precision, powerful modulating actuators in numerous designs



Explosion-proof actuators

Electric actuators for potentially explosive dust and gas atmospheres ATEX Zone 1/21 and Zone 2/22



HVAC actuator PICO

Modular project-specific actuator for the HVAC sector



Linear units: Linearis/Ventaris

High-performance, low-wear linear actuators



Customised solutions

We manufacture customised solutions that are individually tailored to your own specific applications



Actuators Nano / Nano+

High-quality, compact electric actuators
for industrial applications



Nano S, M

- > Robust aluminium housing
- > Cover: melamine
- > Protection rating: IP 66 / IP 67
- > Actuation time: 3 - 120 s/90°
- > Torque: 5 - 60 Nm
- > Ambient temperature: -15 °C ... +60 °C
(optionally -40 °C ... +80 °C
(with PMR: 0 °C ... +60 °C)

Nano+ S, M, L, XL

- > Robust aluminium housing
- > Cover: aluminium
- > Protection rating: IP 66 / IP 67
- > Actuation time: 0.8 - 150 s/90°
- > Torque: 5 - 500 Nm
- > Ambient temperature: -15 °C ... +60 °C
(optionally -40 °C ... +80 °C)
(with PMR: 0 °C ... +60 °C)

Modulating actuators Tensor² / Tensor² Highspeed

High-precision, powerful modulating
actuators in various versions



Tensor² S, M, L

- > Robust aluminium housing
- > Cover: melamine (optional aluminium)
- > Protection rating: IP 66 / IP 67
- > Actuation time: 2 - 210 s/90°
- > Torque: 5 - 200 Nm
- > Ambient temperature: -15 °C ... +60 °C
(optional -20 °C ... +80 °C)

Tensor² Highspeed S, M, L, XL

- > Robust aluminium housing
- > Cover: aluminium
- > Protection rating: IP 66 / IP 67
- > Actuation time: 0.7 - 210 s/90°
- > Torque: 5 - 500 Nm
- > Ambient temperature: -15 °C ... +60 °C
(optional -20 °C ... +80 °C)

Explosion-proof actuators ExTensor Zone 1 and 21 / Tensor²⁺ Zone 2 and 22

Electric actuators for potentially explosive dust and gas environments



ExTensor S, M, L, XL

Approvals / labelling:



ATEX:

- > II 2G Ex db IIC T6 Gb
- > II 2D Ex tb IIIC T80 °C Db
- > -20 °C ≤ Ta ≤ +60 °C



IECEX:

- > Ex db IIC T6 Gb
- > Ex tb IIIC T80 °C Db
- > -20 °C ≤ Ta ≤ +60 °C

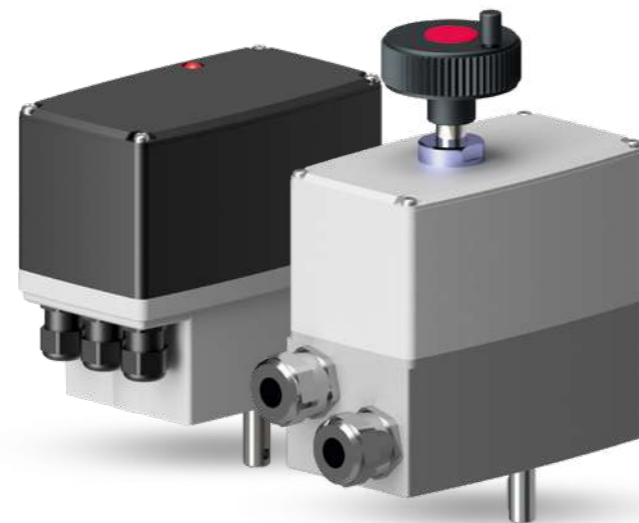

Tensor²⁺ Z2 / Z22

Approvals / labelling:



ATEX:

- > II 3G Ex ec IIC T4 Gc X
- > II 3D Ex tc IIIC T80°C Dc X
- > -15 °C ≤ Ta ≤ +50 °C



IECEX:

- > Ex ec IIC T4 Gc
- > Ex tc IIIC T80 °C Dc
- > -15 °C ≤ Ta ≤ +55°C

Actuator PICO

Modular project-specific actuator for the HVAC sector with a wide range of adaptation and modification options



HVAC actuator PICO

- > Actuation time: 3 - 60 s/90°
- > Position indicator: mechanical
- > Protection rating: IP 65
- > Torque: 5 - 20 Nm
- > Hybrid gearbox (maintenance-free)
- > Ambient temperature: -30 °C ... +50 °C
- > Housing: glass-fibre reinforced polycarbonate
- > 85 - 265 V AC / 24 V DC

Linear units Linearis

Our high-performance and low-wear linear actuators ensure precise linear movements

Linearis

- > Standard stroke lengths: 150 and 300 mm
- > Interchangeable actuator heads - optional
- > High-precision axial needle bearings
- > Stainless steel trapezoidal lead screw
- > Anti-rotation mechanism with maintenance-free Iglidur® special bearings

Product variants:

- > Nano+
- > Tensor², Tensor²-Highspeed
- > ExTensor



Linear units Ventaris

Our high-performance, low-wear linear actuators ensure precise linear movements

Ventaris

- > Standard stroke lengths: 50 and 80 mm
- > Interchangeable actuator heads - optional
- > High-precision axial needle bearings
- > Stainless steel trapezoidal lead screw
- > Anti-rotation mechanism with maintenance-free Iglidur® special bearings

Product variants:

- > Nano+
- > Tensor², Tensor²-Highspeed
- > ExTensor



Special solutions Customised project solutions

We deliver customised solutions that are individually tailored to your applications



ExTensor S **ExTensor M/L** **ExTensor XL**

Sizes S to XL for torques from 5 to 500 Nm

In addition to high-quality actuators, ARIS also supplies robust industrial valves.

On request, our technicians can calculate a complete unit, consisting of valve, mounting fittings and actuator, perfectly tailored to your requirements.

The ready-to-install complete assemblies are set to the required parameters and tested for perfect functionality. Packed securely for transport and fully documented, we will send the complete unit to your desired delivery address – anywhere in the world!



Customised solutions ExTensor complete units

Damper actuators and valve units



ExTensor Linearis

- > Stainless steel trapezoidal lead screw Ø 18 mm
- > Spindle pitch 40 mm/rev
- > High feed rates, low-noise and low-vibration
- > Holding torque thanks to the self-retaining actuator (when energised)
- > Actuator head can be replaced separately
- > High-strength, anodised aluminium machined parts, corrosion-resistant
- > Maintenance-free thanks to dry running, no lubrication required, no dirt adhesion to grease (increased service life)
- > High-quality “dryspin® Technology”, Spindle and nut from igus®



ExTensor Ventaris

- > Stainless steel trapezoidal lead screw Ø 18 mm
- > Spindle pitch 4 mm/rev
- > Precise positioning, low-noise & low-vibration movement of the actuator
- > Self-locking of the actuator thanks to trapezoidal lead screw
- > Actuator head can be replaced separately
- > High-strength, anodised aluminium machined parts in combination with corrosion-resistant stainless steel components
- > Flexible mounting options (direct mounting, flange mounting)
- > Maintenance-free thanks to dry running, no lubrication required, no dirt adhesion to grease (increased service life)
- > High-quality “dryspin® Technology”, Spindle and nut from igus®

Customised solutions Customised project solutions

We manufacture customised solutions that are individually tailored to your applications



Stepper motor

Easy-to-operate stepper motor, customised for the client's project

- > Thanks to the round housing geometry, the damper actuator can be easily integrated into the customer's application and the existing design
- > The gear reduction (torque and actuation time) is optimised for the project-specific application
- > A Hall sensor mounted directly on the output shaft allows contactless position detection
- > The integrated stepper motor controller combines the stepper motor and motion control into one space-saving unit



LED floodlight actuator

Actuator for adjusting LED floodlights on mobile cranes and fire brigade ladder vehicles

- > Compact motor-gearbox combination with integrated control electronics
- > Controlled via the vehicle's PWM signals
- > Mechanical overload clutch to prevent damage from external overload
- > The actuator is tested for compliance with the IP protection rating
- > The actuator complies with all EMC requirements and is therefore approved for operation within the fire brigade's radio network

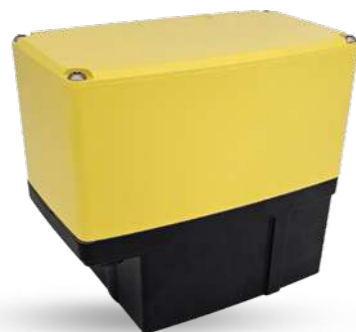

OEM actuator Nano+

OEM actuator based on Nano+

- > The actuator has a special finish; a powder coating in black and yellow
- > Tailored to customer specifications, the actuator has a particularly slow actuation time of 120 s/90°



Actuator Zone 2 and 22

ATEX / IECEx actuator Zone 2 and 22
Use on dosing pumps

- > Tailor-made actuator with customised special housing
- > The cable inlets are fitted with 2x½" NPT cable glands
- > Painted in standardised RAL colour on customer request
- > Electronics with individual presetting and practical menu lock
- > The special actuator is equipped with 4 mm² connection terminals



OEM customer-specific actuator

Series OEM customer-specific actuator for industrial burners for gas and air control

- > Special electronic design for the high demands of gas and air control
- > Connection via M12 plug connector on customer request
- > The OEM customer-specific actuator is equipped with a protective pressure equalisation element

01.

We produce special actuators with customised motors that are tailored to your own specific application and area of use right down to the smallest detail.

03.

Whether ATEX certification or special approval - based on your project-specific requirements, we deliver solutions that are tested in line with the highest standards of quality and safety.

05.

Resource efficiency and cost-effectiveness are at the forefront of the production of your special actuator or complete solution.

02.

We design made-to-measure housing geometries for easy integration into the existing design or process.

04.

We customise our actuator solutions to meet the challenges of your industry. Our decades of market experience are the basis for every customised solution.

06.

Nothing is impossible: from the choice of material to special finishes, connection forms and equipment features, we can realise even the most bespoke requirements in our own production facilities. Do not hesitate to contact us.

ARIS – Experts in motion

Pneumatic actuators



Pneumatic actuators

Torque 5 to 5000 Nm
Swivel range 70° to 110°

ARIS pneumatic quarter-turn actuators deliver a consistent torque in a slimline housing for both double and single-acting designs. The pneumatic actuators are available with an extensive range of accessories and various options.

We supply the actuators individually or fully mounted on valves.

PD/PE actuators (from type 15) are equipped with mechanical end stops that allow adjustment of $\pm 10^\circ$ in both directions. This enables a swivel range of between 70° and 110°.

The mechanical end stops can absorb the maximum torque and the maximum effective force. To increase the resistance of the pistons, the mechanical end stops fix the pistons at their strongest points. The left/right rotation is set by turning the corresponding adjusting screws for left (MAX) and right stop (0°).



Pneumatic actuator PD/PE

- > Housing: anodised aluminium
- > Connections in accordance with DIN/ISO/Namur
- > Adjustable mechanical end stop
- > Pre-tensioned, secured springs
- > Position indicator
- > SIL2 approval
- > Torques 30 - 75 Nm



Pneumatic actuator PD-S/PE-S

- > Housing: technopolymer
- > PD-S: double-acting actuators
- > PE-S: single-acting actuators
- > Torques 5 - 65 Nm



Pneumatic actuator PD-P/PE-P

- > Housing: technopolymer
- > Torques 10 - 18 Nm

ARIS – Experts in motion

Industrial valves for all your applications



Industrial valves

Industrial valves of all types and sizes for almost all applications

Throttle valves

Ring-type throttle valves, flange throttle valves
High-temperature butterfly valves, gas volume control valves



Butterfly and control valves

Butterfly valves, gas butterfly valves
Complete assemblies, special valves



Control valves

2- or 3-way design



Ball valves

Brass ball valves, stainless steel ball valves
Flanged ball valves



Mixing valves

Mixing valve ADR



Industrial valves

Industrial valves of all types and sizes for almost all applications



Ring-type throttle valve RD-K

- > For clamping between flanges PN 6/10/16
- > Corrosion-resistant coating on the outside
- > Stuffing box and union nut made of brass
- > High-pressure stuffing box packing with graphite seal



Ring-type throttle valve L5-RD

- > Ring design
- > For clamping between flanges DIN 24154
- > 2nd shaft end optional (for example for proximity switch input)
- > High-pressure stuffing box packing with graphite seal
- > Higher temperatures on request



Flange throttle valve L6-FD

- > Flanged design
- > With two welded-on flanges DIN 24154 T2 R2
- > 2nd shaft end optional (for example for proximity switch input)
- > Corrosion-resistant coating
- > High-pressure stuffing box packing with graphite seal
- > Higher temperatures on request



High-temperature ring-type throttle valve HT-L

- > Robust industrial design
- > For clamping between flanges PN6/10/16 and ANSI
- > High-pressure stuffing box packing with graphite seal
- > 2nd shaft end optional (for example for proximity switch input)

Industrial valves

Industrial valves of all types and sizes for almost all applications



High-temperature ring-type throttle valve HT2-B

- > Heavy-duty industrial design
- > For clamping between flanges PN 6/10/16 and ANSI
- > External bearing on both sides from DN 450
- > High-pressure stuffing box packing with graphite seal
- > 2nd shaft end optional (for example for proximity switch input)



Butterfly valve AFV

- > Ring design as intermediate fitting
- > For clamping between ANSI 150 and PN 10/16 flanges
- > Tight-closing in accordance with EN 12266-1, Leakage class A
- > Face-to-face dimensions in accordance with EN 558-1, series 20 (DIN 3202 K1)
- > Flange head: ISO 5211 - DIN 3337
- > Epoxy resin coated



GRK gas volume control valve

- > For clamping between flanges PN 6/10/16
- > Body with sealing grooves on the end faces
- > DVGW tested
- > EC type examination certificate DIN 3394-1, DIN 3391
- > For gases of the 1st, 2nd and 3rd gas family



Gas butterfly valve

- > Ring design
- > For clamping between flanges PN 6/10/16 and ANSI
- > Tight-closing in accordance with EN 12266-1, Leakage class A
- > Replaceable sleeve
- > Housing: aluminium or stainless steel

Industrial valves

Industrial valves of all types and sizes for almost all applications



Control valve RV 102

- > 2- or 3-way design: (102-2 or 102-3)
- > Media temperature: 0 °C ... +150 °C
- > Connection: nozzle with internal thread EN ISO 228/1
- > Face-to-face dimensions: DIN 3202 M4
- > Nominal pressure: PN 16
- > Cone type: cylindrical with cut-outs
- > Flow characteristic: linear/equal percentage
- > kvs values: 0.6 ... 40m³/h
- > Nominal pressure: Class III. EN 1349 (<0.1% kvs)
- > Control ratio: 50:1



Control valve RV 113

- > 2- or 3-way design: (113-2 or 113-3)
- > Media temperature: 2 °C ... +150 °C
- > Connection: Flanges type B1 (coarse sealing strip) EN 1092-2
- > Face-to-face dimensions: Series 1 in accordance with EN 558-1
- > Nominal pressure: PN 16
- > Cone type: cylindrical with cut-out and soft sealing set
- > Flow characteristic: equal percentage
- > kvs values: 40 ... 360m³/h
- > Nominal pressure: Class IV.-S1 EN 1349 (<0.0005% kvs)
- > Control ratio: 50:1



Control valve RV 103

- > 2- or 3-way design: (103-2 or 103-3)
- > Media temperature: 0 °C ... +150 °C
- > Connection: Flanges type B1 (coarse sealing strip) EN 1092-2
- > Face-to-face dimensions: Series 1 in accordance with EN 558-1
- > Nominal pressure: PN 16
- > Cone type: cylindrical with cut-outs
- > Flow characteristic: linear/equal percentage
- > kvs values: 0.6 ... 40m³/h
- > Nominal pressure: Class III. EN 1349 (<0.1% kvs)
- > Control ratio: 50:1



Brass ball valve MKH

- > Brass ball valve
- > Blow-out-proof spindle, triple sealed
- > Full-bore ball with end-to-end consistency
- > Low actuating torque
- > Suitable for hot and cold water, air, hydrocarbons and non-corrosive liquids
- > Media temperature: -20 °C ... +130 °C
- > Connection: ISO 7/1 - NPT
- > Face-to-face dimensions: DIN 3202 T4 (M3)



Flanged ball valve KH 525/528

- > 2-part
- > Cone with full-bore ball
- > End-to-end consistency



Stainless steel ball valve 014/015

- > 2-piece
- > Blow-out-proof spindle
- > Cone with full-bore ball



Stainless steel ball valve KH 025

- > 3-piece
- > Blow-out-proof spindle
- > Cone with full-bore ball



ADR mixing valve

- > 3-way mixing or flow control valve
- > Double O-ring seal
- > Medium: heating water, glycol-water mixtur

ARIS – Experts in motion

Gas control systems / components

Gas control systems / components

We can supply you with all the components required for gas conditioning and control with the legally required approvals (European standard, in some cases DVGW).

We offer a high-quality range of products from shut-off ball valves and solenoid shut-off valves to pressure gauges for monitoring upstream and downstream pressure, safety relief valves and pressure switches. Whether you need a gas flow meter, a valve testing system or burner control, we have the right products in stock and are able to deliver innovative solutions for your application.

In addition to the individual components, we can also provide you with all the necessary pipework, including yellow or blue paintwork, right through to a fully assembled gas control system.



Gas pressure regulator

- > Max. inlet pressure: 0.5; 1; or 2 bar
- > Outlet pressure: 10 to 300 mbar
- > Connection: ½" to 2" (threaded connection)
DN25 to DN150 (flanged connection)
- > Temperature range: -20 °C ... +60 °C
- > Approval: DIN EN 88-1:2011 PED

Safety relief/overflow valves

- > Pmax: 1 bar
- > Actuation range: 20 - 600 mbar
- > Temperature range: -20 °C ... +60 °C
- > Connection: ½" to 2" (threaded connection)
DN25 to DN150 (flanged connection)
- > Housing: aluminium
- > Seal: NBR 60Sh - DVGW EN 59
- > Approval: 2014/68/UE PED

Gas control systems / components

Components for gas conditioning and control



Gas filter

- > Max. pressure: 6 bar
- > Permissible temperature: -20 °C ... +60 °C
- > Degree of filtration: < 50 microns
- > Connection: ½" to 2" (threaded connection)
- > DN25 to DN150 (flanged connection)
- > Housing: aluminium
- > Seal: NBR
- > Approval: PED 2014/68/UE
- > Options: Test connection, pressure gauge, clogging indicator, screw plugs



Solenoid valves

- > Pmax: 360 mbar/6 bar
- > Actuation time: opening < 1 s; closing < 1 s
- > Voltage: 230 V AC; 115 V AC, 24 V DC
- > Temperature range: -20 °C ... +60 °C
- > Connection: ½" to 2"
- > DN 25 to DN 100
- > Protection rating: IP 65
- > Approval: DIN EN 161



Safety relief valves

- > Max. pressure: 6 bar
- > Set point: 60 - 700 mbar
- > Closing time: <1 second
- > Permissible ambient temperature: -15 °C ... +70 °C
- > Protection rating: IP 65
- > Nominal widths: ½" to 2" (threaded connection), DN65 to DN100 (flanged connection)
- > Seal: NBR
- > Housing: Brass up to 2"/DN 50, aluminium DN 65 - 100
- > Approval: PED



Pressure switch

- > Pmax: 500 mbar/690 mbar/1 bar
- > Switching pressure: 0.4 to 500 mbar
- > Pressure housing: Brass/aluminium
- > Seal: NBR
- > Temperature range: -15 °C ... +60 °C
- > Switching capacity: 6 A/250 V AC
- > Protection rating: IP 54/IP 44 as differential pressure switch
- > Connection: ¼"

Gas control systems / components

Components for gas conditioning and control



Ball valves

- > Housing: nickel-plated brass
- > Shaft: GJS 400-15
- > O-ring: NBR
- > Seat: PTFE
- > Max. pressure: 5 bar (threaded version)
- > 16 bar (flange version)
- > Temperature: -20 °C ... +60 °C
- > Connection: ¼" to 4" threaded connection (brass) DN15 to DN200 flanged connection (cast steel)



Stainless steel compensator

- > Material: AISI 321
- > Max. temperature: 300 °C
- > Max. pressure: 10 bar
- > Length: 150 - 200 mm
- > Connection: ½" to 2 ½" (threaded connection) DN50 to DN250 (flanged connection)



Gas volume control dampers

- > Housing: aluminium
- > Shaft AISI 303
- > Disc aluminium or AISI 304
- > Max. pressure 500 mbar
- > Temperature gas: -10 °C ... +60 °C
- > Air temperature: -10 °C ... +80 °C
- > Control ratio 10:1
- > Retracted designs available in 1 or 2 nominal widths



Flexible connection hoses

- > Material: AISI 321/304
- > Temperature range: -20 °C ... +600 °C
- > Max. pressure: 16 bar (air)
- > 4 bar (gas)
- > Length as required
- > Connection: 3/8" to 2" (threaded connection) DN10 to DN100 (flanged connection)

Gas control systems / components

Components for gas conditioning and control



Burner control unit (EFC series)

The burner control units of the EFC series are designed to detect a flame in single or two-stage industrial gas burners with intermittent operation.

The status of the burner is clearly indicated by the various LED lights on the front panel. The EFC can be supplied with an internal ignition transformer and can also control one or two solenoid valves.

Flame detection can be via a single rod, two rods or a UV cell. Remote control of the burner control is also possible.

The EFC series is supplied in a fireproof thermoplastic housing that allows installation next to the burner.

It is also available in a rack version for control panel applications. The EFC burner control unit is manufactured in accordance with EC Directive 90/396/EEC and EN298 standards.



Valve testing system MTC10

MTC10 is a device for checking the tightness of the two automatic valves before each start-up of the burner or after each shutdown. Whenever a leakage is detected at one of the gas valves, MTC10 prevents the burner from starting.

MTC10 is manufactured in accordance with the EN746-2 standard, which states that the installation of a leakage test is mandatory in systems with a capacity of over 1200 kW.

This device can be used on industrial and domestic gas burners with or without a vent pipe. CE-certified in accordance with EN1643. Conformity in accordance with Directive 2009/142/CE (Gas Directive), Directive 2004/108/CE (EMC) and Directive 94/9/CE (ATEX Directive).



Pressure gauges

Our pressure gauges are specially designed for measuring low pressures in mbar, in accordance with EN 837-3, or high pressures in bar.

They are suitable for use in natural gas firing systems and for measuring the pressure of non-corrosive liquids in a gaseous state.

They are available with a radial external thread 1/4" - 3/8" - 1/2" and with a dial diameter of 63 - 80 and 100 mm.

The standard version is equipped with a double scale in mbar and in H₂O mm.

A shut-off valve is connected upstream of each pressure gauge to allow easy replacement of the pressure gauges in the event of a fault.



Gas flow meter

Quantometers are designed to provide a reliable and cost-effective measuring device (non-fiscal) with similar features to the turbine wheel gas meter.

They are maintenance-free and can be connected to external appliances.

The gas flow meter evaluates the ratio between the incoming gas and the wheel speed. The rotational speed is proportional to the flow volume during operation.

The rotary movement activates the measuring unit on the top of the quantometer via a mechanical/magnetic coupling, which reports the gas volume during operation. The quantometers are CE and PED 2014/68/EU certified.

OVERVIEW

Gas control system

All components required for gas conditioning and regulation with the legally required approvals (European standard, in some cases DVGW).

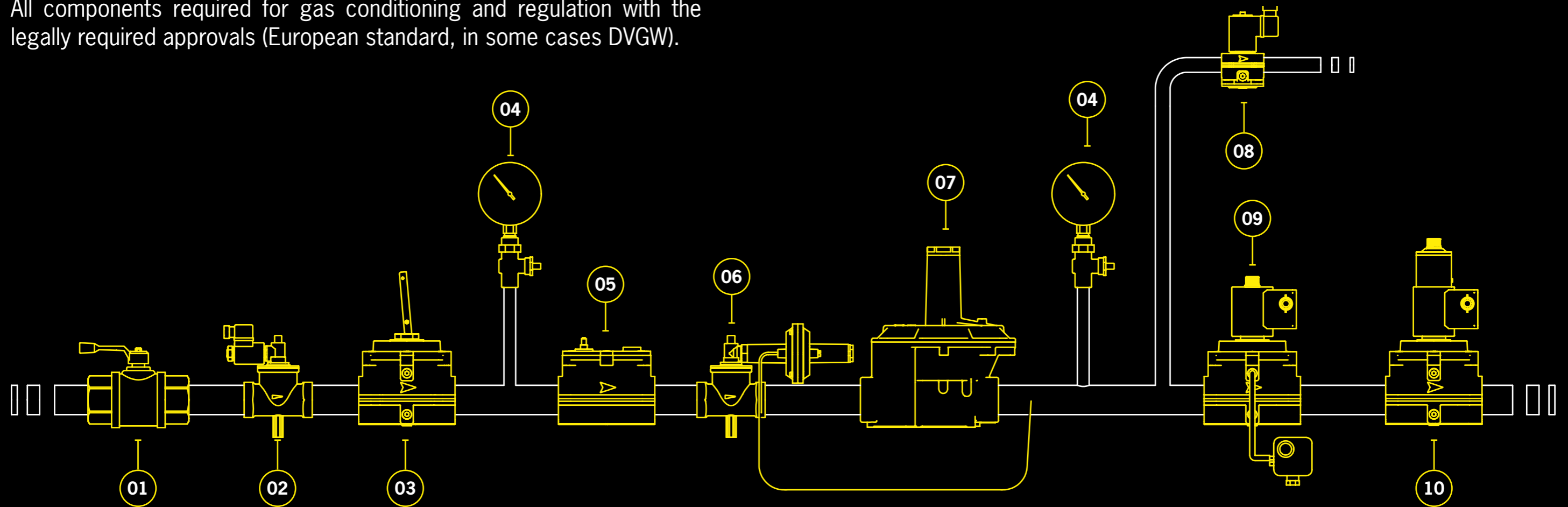

01
Shut-off ball valve
For separating the gas control system from the supply.

02
Solenoid shut-off valve
For gas separation, e.g. triggered by a gas detector.

03
Manually operated quick-acting shut-off valve
For fast and secure closing with minimised pressure loss when open. Remote monitoring is possible; the closing process is faster and more secure than with conventional ball valves.

04
Pressure gauge
The pressure gauges are installed to monitor the upstream and downstream pressure. A shut-off valve is installed upstream of each pressure gauge to allow easy replacement of the pressure gauges in the event of a fault.

05
Gas filter
protects the rest of the system from dirt or dust carried along with the gas flow. Deposits can, for example, consist of parts accidentally left in the pipe during construction.

06
Safety shut-off valve/overpressure shut-off valve
is installed after the filter and before the pressure regulator. The overpressure shut-off valve closes the gas supply if the downstream pressure exceeds a specified limit value.

07
Gas regulator
is a control valve that reduces the inlet pressure of a fluid at its outlet to a desired value.

08
Safety relief valve
is set to a higher pressure than the pressure relief valve so that the safety relief valve operates when the pressure relief valve is not working.

09
Pressure switches
are intended for switching a circuit on and off or switching it over when the actual pressure value changes depending on the pressure setpoint.

10
Solenoid valve
is intended for securing and controlling the air and gas supply to gas burners and gas appliances.

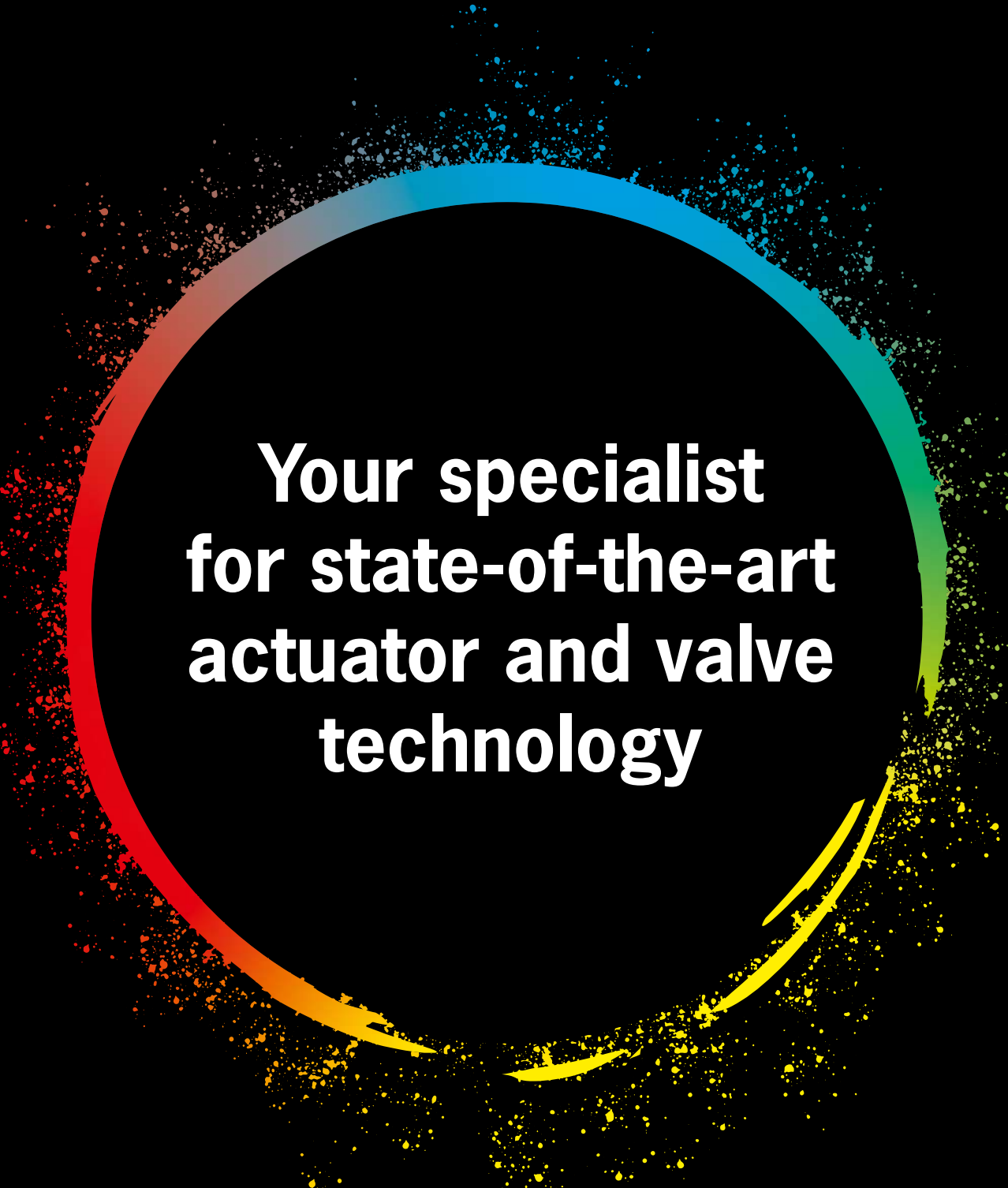

**Your specialist
for state-of-the-art
actuator and valve
technology**

PUBLISHED BY

ARIS Stellantriebe GmbH
Rotter Viehtrift 5a-9
D-53842 Troisdorf

CONCEPT & DESIGN

RSB Design GmbH
Berthold-Beitz-Boulevard 492
D-45141 Essen

Picture credits page 1:

zhu difeng/Shutterstock.com

Picture credits pages 8-9:

Cagkan Sayin/Shutterstock.com
Therina Groenewald/Shutterstock.com
Jenson/Shutterstock.com
selgakristaps/Shutterstock.com
Cergios/Shutterstock.com
Alexxey/Shutterstock.com
cheetahok/Shutterstock.com
Natascha Kaukorat/Shutterstock.com
EvijaF/Shutterstock.com
Lightpoet/Shutterstock.com
Salov Evgeniy/Shutterstock.com
GolubSergei/Shutterstock.com
Fly_and_Dive/Shutterstock.com
Christian Lagerek/Shutterstock.com
DedMityay/Shutterstock.com
sergeisimonov/Shutterstock.com
Surasak_Photo/Shutterstock.com
Roman Zaiets/Shutterstock.com
Martin M303/Shutterstock.com
tonton/Shutterstock.com
Jenson/Shutterstock.com
Rudmer Zwerver/Shutterstock.com
DifferR/Shutterstock.com
Davi Piaia/Shutterstock.com
SpockyPo/Shutterstock.com

Picture credits page 18:

leungchopan/Shutterstock.com

Picture credits page 30:

FUN FUN PHOTO/Shutterstock.com

Picture credits page 32:

Steve Allen/Shutterstock.com

PLEASE NOTE:

Although all the data in this catalogue has been carefully checked, we cannot accept liability for any incorrect or incomplete information. We reserve the right to make technical modifications. The reproduction, distribution and utilisation of this document as well as the communication of its contents to others without express authorisation is prohibited. The images are for illustrative purposes only and may vary from the actual items supplied.

Your specialist for modern drive and valve technology

ARIS Stellantriebe GmbH
Rotter Viehtrift 5a-9
D-53842 Troisdorf

Tel.: +49 2241-25186-0
Fax: +49 2241-25186-99
aris@stellantriebe.de

stellantriebe.de/en

