

Pressure switch Series - PM11-SC

Product code: PM11-SC

Datasheet creation date: 10/12/2025 08:38

Check the most updated document online [click here](#)



TECHNICAL DATA

Mod.	PM11-SC
Function	SC (*)
Max voltage	250V AC - 30V 30V DC
Working temperature	-25°C +85°C
Speed	> 0,1 ms
Regulation range	2 ÷ 10 bar
Max hysteresis	0.8 bar

Pressure switch Series - PM11-SC

Product code: PM11-SC

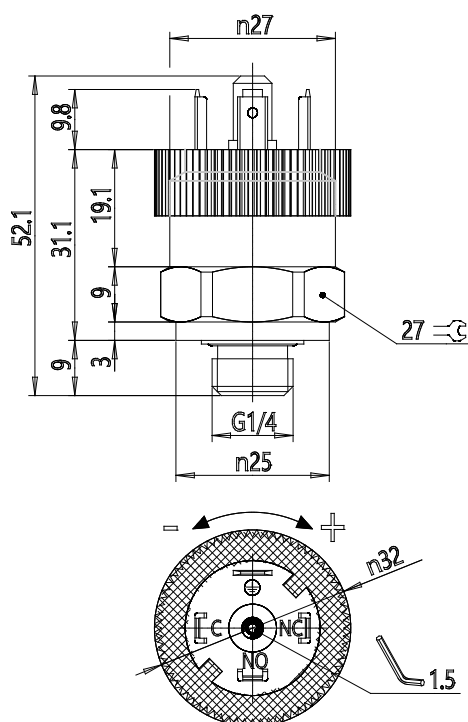

DIMENSIONS

Mod.	PM11-SC
Function	SC (*)
Max voltage	250V AC - 30V 30V DC
Working temperature	-25°C +85°C
Speed	> 0,1 ms
Regulation range	2 ÷ 10 bar
Max hysteresis	0.8 bar